

RAIMONDI®
SINCE 1863

LR330

18t 

www.raimondi.co     

Raimondi Cranes is proudly headquartered in our ancestral home of Legnano
Corso Garibaldi, 253 - 20025 Legnano, Milan, Italy | +39 0331 548 061 | info@raimondicranes.com
Fourth Floor, Meydan Office Towers, Meydan Hotel, Nad Al Sheba, Dubai, UAE PO Box 644753 | +971 (0)4 381 3755

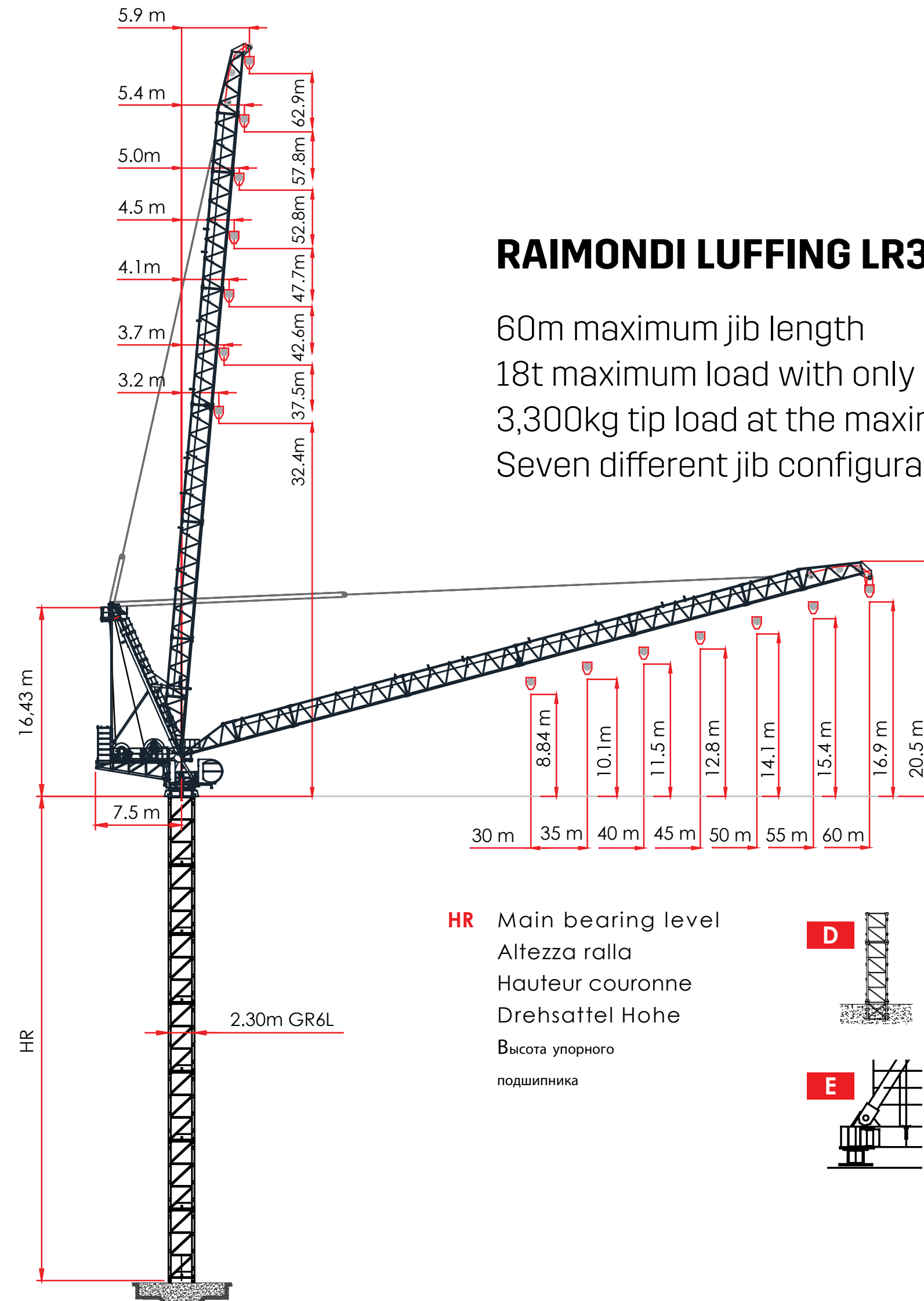

RAIMONDI LUFFING LR330

60m maximum jib length
18t maximum load with only II Falls
3,300kg tip load at the maximum length
Seven different jib configurations from 60m to 30m

HR Main bearing level
Altezza ralla
Hauteur couronne
Drehsattel Höhe
Высота упорного
подшипника

D HR 42,4 m C25
Jib 60 m
GR6L

E 8,0 x 8,0 m
HR 49,3 m C25
Jib 60 m
GR6L

LOAD DIAGRAM | FALLS UL

UL ULTRALIFT

ALL INTERMEDIATE LOADS ARE INCREASED OF 10% WITH ULTRALIFT CONTROL

LR 330 Load Diagram 9.0 t Ultralift

	RADIUS																																					
	5	6	8	10	12	14	16	18	20	21	22	23	24	25	26	28	30	32	34	35	36	38	40	42	44	45	46	48	50	52	54	55	56	58	60			
30 m	9000	9000	9000	9000	9000	9000	9000	9000	9000	9000	9000	9000	9000	9000	9000	9000	9000																					
35 m	9000	9000	9000	9000	9000	9000	9000	9000	9000	9000	9000	9000	9000	9000	9000	9000	9000	9000	9000	9000																		
40 m	9000	9000	9000	9000	9000	9000	9000	9000	9000	9000	9000	9000	9000	9000	9000	9000	9000	9000	9000	9000	9000	9000	9000	9000														
45 m	9000	9000	9000	9000	9000	9000	9000	9000	9000	9000	9000	9000	9000	9000	9000	9000	9000	9000	9000	9000	9000	9000	9000	9000	8440	8630	8250											
50 m	9000	9000	9000	9000	9000	9000	9000	9000	9000	9000	9000	9000	9000	9000	9000	9000	9000	9000	9000	9000	9000	9000	9000	8510	8665	8030	7735	7450	6660	6380								
55 m	9000	9000	9000	9000	9000	9000	9000	9000	9000	9000	9000	9000	9000	9000	9000	9000	9000	9000	9000	9000	9000	9000	8310	8450	7825	7260	5890	5640	6260	5825	5415	5035	4840					
60 m	9000	9000	9000	9000	9000	9000	9000	9000	9000	9000	9000	9000	9000	9000	9000	9000	9000	9000	9000	8735	8370	8460	7790	7185	6635	6375	6130	5665	5240	4845	4480	4305	4140	3820	3520			

LOAD DIAGRAM II FALLS UL



UL ULTRALIFT

ALL INTERMEDIATE LOADS ARE INCREASED OF 10% WITH ULTRALIFT CONTROL

LR 330 Load Diagram 18.0 t Ultralift

	RADIUS																																				
	5	6	8	10	12	14	16	18	20	21	22	23	24	25	26	28	30	32	34	35	36	38	40	42	44	45	46	48	50	52	54	55	56	58	60		
30 m	12000	18000	18000	18000	18000	18000	18000	22722	20120	19004	17990	17063	16213	15431	14708	13414	12288																				
35 m	18000	18000	18000	18000	18000	18000	18000	18000	18000	18000	16785	15080	13645	12420	11360	12420	11360	10430	9615	8800																	
40 m	18000	18000	18000	18000	18000	18000	18000	18000	18000	18000	18000	18000	18000	17040	16225	14780	13530	12440	11480	11040	10625	9865	8800														
45 m	18000	18000	18000	18000	18000	18000	18000	18000	18000	18000	18000	18000	18000	18000	16725	15170	13830	12660	11625	11155	10710	9890	9155	8490	8675	8030											
50 m	18000	18000	18000	18000	18000	18000	18000	18000	18000	18000	18000	18000	18000	16805	15955	14435	13125	11980	10970	10510	10075	9275	8560	8700	8050	7745	7455	6910	6160								
55 m	16000	16000	16000	16000	16000	16000	16000	16000	16000	16000	16000	16000	15110	14345	13635	12370	11270	10305	9455	9065	8695	8815	8140	7530	6970	6710	6460	5995	5565	5165	4795	4620					
60 m	14000	14000	14000	14000	14000	14000	14000	14000	14000	14000	14000	14000	14000	14000	14000	11640	10565	9630	8800	8420	8865	8135	7480	6885	6345	6090	5850	5395	4975	4590	4230	4060	3895	3580	3300		

TOWER 2,30 m  **GR6L**
E  **2,3 m GR6L - Base on concrete pads - L 8,0 x 8,0 m - EN14439 C25**



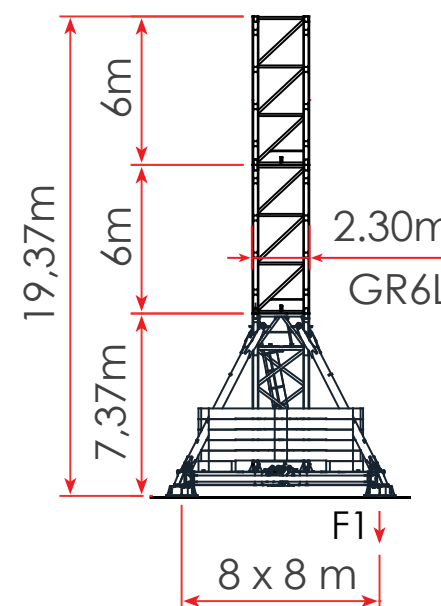



































































Ei	60			55			50			45			40			35			30		
	HT		Δ	HT		Δ	HT		Δ	HT		Δ	HT		Δ	HT		Δ	HT		Δ
+9													58,37		3	58,37		3	58,37		3
+8				52,37		3	55,37		6	55,37		6	55,37		6	55,37		6	55,37		6
+7	49,37		6	49,37		6	49,37		6	49,37		6	49,37		6	49,37		6	49,37		6
+6	43,37		6	43,37		6	43,37		6	43,37		6	43,37		6	43,37		6	43,37		6
+5	37,37		6	37,37		6	37,37		6	37,37		6	37,37		6	37,37		6	37,37		6
+4	31,37		6	31,37		6	31,37		6	31,37		6	31,37		6	31,37		6	31,37		6
+3	25,37		6	25,37		6	25,37		6	25,37		6	25,37		6	25,37		6	25,37		6
+2	19,37		6	19,37		6	19,37		6	19,37		6	19,37		6	19,37		6	19,37		6



Jib ▶	60 m		55 m		50 m		45 m		40 m		35 m		30 m	
HT (m)	Z (ft)	F1↓ (kN)	Z (ft)	F1↓ (kN)	Z (ft)	F1↓ (kN)	Z (ft)	F1↓ (kN)	Z (ft)	F1↓ (kN)	Z (ft)	F1↓ (kN)	Z (ft)	F1↓ (kN)
58,37									146	1864	176	1778	176	1657
55,37					176	1913	176	1811	176	1673	166	1595	176	1503
52,37			156	1848	166	1714	166	1622	166	1515	166	1444	166	1389
49,37	156	1836	156	1655	146	1554	146	1468	136	1363	136	1298	136	1240
43,37	126	1494	116	1355	116	1260	116	1185	106	1105	106	1063	106	1201
37,37	96	1217	96	1089	86	1018	86	973	86	1075	86	1023	86	956
31,37	76	972	76	909	76	989	76	932	86	906	86	911	86	918
25,37	76	865	76	895	76	838	76	839	76	846	76	851	76	860
19,37	76	852	76	795	76	804	76	806	76	813	76	819	76	805

Ei (n.) Number of tower elements **HT (m)** Total tower height **F1↓** Maximum compression
Δ (m) Δ Element height **Z (ft)** Total Ballast **F2↑** Maximum traction

D  **2,3 m GR6L - Crane on embedded element - EN14439 C25**

Elev	60			55			50			45			40			35			30					
	HT		Δ	HT		Δ	HT		Δ	HT		Δ	HT		Δ	HT		Δ	HT		Δ			
+ 9													51,40		3	51,40		3	54,40		6			
+ 8				48,40			48,40		6	48,40		6	48,40		6	48,40		6	48,40		6			
+ 7	42,40		6	42,40		6	42,40		6	42,40		6	42,40		6	42,40		6	42,40		6	42,40		6
+ 6	36,40		6	36,40		6	36,40		6	36,40		6	36,40		6	36,40		6	36,40		6	36,40		6
+ 5	30,40		6	30,40		6	30,40		6	30,40		6	30,40		6	30,40		6	30,40		6	30,40		6
+ 4	24,40		6	24,40		6	24,40		6	24,40		6	24,40		6	24,40		6	24,40		6	24,40		6
+ 3	18,40		6	18,40		6	18,40		6	18,40		6	18,40		6	18,40		6	18,40		6	18,40		6
+ 2	12,40		6	12,40		6	12,40		6	12,40		6	12,40		6	12,40		6	12,40		6	12,40		6
+ 1	6,40		6	6,40		6	6,40		6	6,40		6	6,40		6	6,40		6	6,40		6	6,40		6



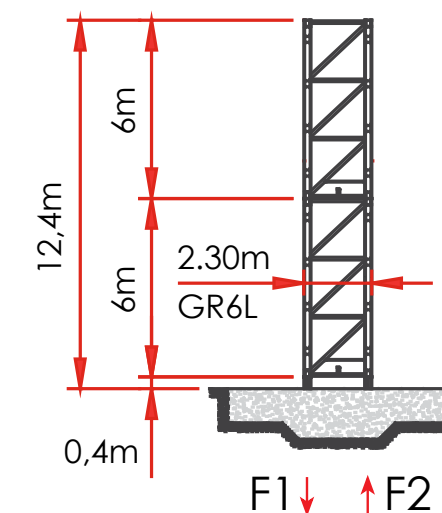

















































































Jib ▶	60 m		55 m		50 m		45 m		40 m		35 m		30 m		
	HT (m)	F1↓ (kN)	F2↑ (kN)	F1↓ (kN)	F2↑ (kN)	F1↓ (kN)	F2↑ (kN)	F1↓ (kN)	F2↑ (kN)	F1↓ (kN)	F2↑ (kN)	F1↓ (kN)	F2↑ (kN)	F1↓ (kN)	F2↑ (kN)
54,40														3243	2705
51,40									3296	2739	3123	2596	2910	2383	
48,40				3597	2992	3399	2820	3199	2649	2941	2396	2791	2275	2639	2124
42,40	3271	2706	2936	2376	3037	2469	2856	2317	2665	2132	2527	2023	2358	1854	
36,40	2651	2109	2418	1881	2760	2203	2590	2063	2376	1853	2250	1758	2159	1613	
30,40	2175	1656	1906	1392	2210	1676	2063	1559	1965	1377	2010	1452	2019	1461	
24,40	1706	1210	1638	1068	1793	1228	1819	1249	1834	1269	1883	1348	1895	1360	
18,40	1486	943	1530	983	1670	1094	1700	1153	1718	1175	1771	1259	1785	1273	
12,40	1390	871	1435	910	1562	1008	1595	1071	1616	1096	1672	1183	1689	1200	



EI (n.)	Number of tower elements	HT (m)	Total tower height	F1↓	Maximum compression
Δ (m)	Δ Element height	Z (t)	Total Ballast	F2↑	Maximum traction

TOWER 2,30 m  GR6 /  GR6L







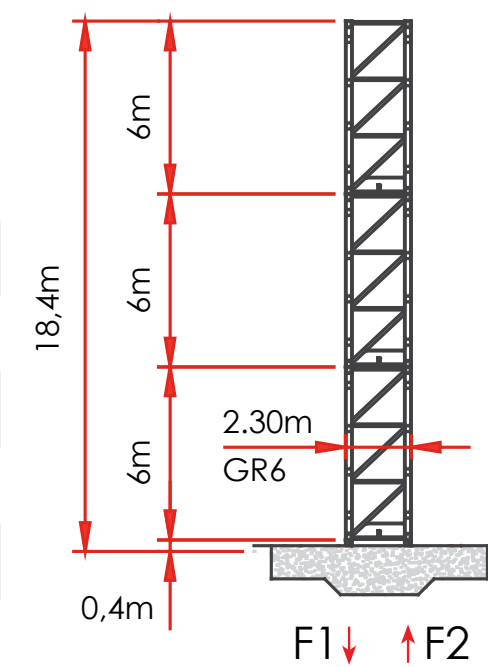





























D  2,3 m GR6 - Crane on embedded element - EN14439 C25

Elev	60			55			50			45			40			35			30		
	HT		Δ	HT		Δ	HT		Δ	HT		Δ	HT		Δ	HT		Δ	HT		Δ
+12													66,40			66,40		3	69,40		3
+11							60,40		3	63,40		3	63,40		3	63,40		3	66,40		3
+10	54,40		3	57,40		3	57,40		3	60,40		3	60,40		6	60,40		6	60,40		6
+9	51,40		3	54,40		3	54,40		6	54,40		6	54,40		6	54,40		6	54,40		6
+8	48,40		6	48,40		6	48,40		6	48,40		6	48,40		6	48,40		6	48,40		6
+7	42,40		6	42,40		6	42,40		6	42,40		6	42,40		6	42,40		6	42,40		6
+6	36,40		6	36,40		6	36,40		6	36,40		6	36,40		6	36,40		6	36,40		6
+5	30,40		6	30,40		6	30,40		6	30,40		6	30,40		6	30,40		6	30,40		6
+4	24,40		6	24,40		6	24,40		6	24,40		6	24,40		6	24,40		6	24,40		6
+3	18,40		6	18,40		6	18,40		6	18,40		6	18,40		6	18,40		6	18,40		6
+2	12,40		6	12,40		6	12,40		6	12,40		6	12,40		6	12,40		6	12,40		6
+1	6,40		6	6,40		6	6,40		6	6,40		6	6,40		6	6,40		6	6,40		6

Jib	60 m		55 m		50 m		45 m		40 m		35 m		30 m	
HT (m)	F1↓ (kN)	F2↑ (kN)	F1↓ (kN)	F2↑ (kN)	F1↓ (kN)	F2↑ (kN)	F1↓ (kN)	F2↑ (kN)	F1↓ (kN)	F2↑ (kN)	F1↓ (kN)	F2↑ (kN)	F1↓ (kN)	F2↑ (kN)
69,40													5068	4450
66,40									5195	4558	4937	4330	4587	3980
63,40							5032	4403	4715	4089	4487	3891	4210	3615
60,40					4888	4240	4566	3947	4339	3726	4128	3544	3840	3257
57,40			4751	4077	4423	3786	4205	3598	3950	3348	3756	3183	3556	2983
54,40	4674	4041	4272	3644	4068	3443	3829	3233	3600	3009	3421	2860		
51,40	4230	3608	3931	3314	3698	3085	3513	2928						
48,40	3890	3287												



TOWER 2,30 m  **GR6B** /  **GR6** /  **GR6L**

D		☑ 2,3 m GR6B - Crane on embedded element - EN14439 C25																	
▲▲▲	60	55			50			45			40			35			30		
EI	HT	☑	Δ	HT	☑	Δ	HT	☑	Δ	HT	☑	Δ	HT	☑	Δ	HT	☑	Δ	
+13																78,40		3	
+12										72,40		3	75,40		3	75,40		3	
+11				66,40		3	69,40		3	69,40		3	72,40		6	72,40		6	
+10	63,40		3	63,40		3	66,40		6	66,40		6	66,40		6	66,40		6	
+9	60,40		6	60,40		6	60,40		6	60,40		6	60,40		6	60,40		6	
+8	54,40		6	54,40		6	54,40		6	54,40		6	54,40		6	54,40		6	
+7	48,40		6	48,40		6	48,40		6	48,40		6	48,40		6	48,40		6	
+6	42,40		6	42,40		6	42,40		6	42,40		6	42,40		6	42,40		6	
+5	36,40		6	36,40		6	36,40		6	36,40		6	36,40		6	36,40		6	
+4	30,40		6	30,40		6	30,40		6	30,40		6	30,40		6	30,40		6	
+3	24,40		6	24,40		6	24,40		6	24,40		6	24,40		6	24,40		6	
+2	18,40		6	18,40		6	18,40		6	18,40		6	18,40		6	18,40		6	
+1	12,40		12	12,40		12	12,40		12	12,40		12	12,40		12	12,40		12	

Jib ▶	60 m		55 m		50 m		45 m		40 m		35 m		30 m	
HT	F1↓	F2↑	F1↓	F2↑	F1↓	F2↑	F1↓	F2↑	F1↓	F2↑	F1↓	F2↑	F1↓	F2↑
(m)	(kN)	(kN)	(kN)	(kN)	(kN)	(kN)	(kN)	(kN)	(kN)	(kN)	(kN)	(kN)	(kN)	(kN)
78,40													6492	5811
75,40									6664	5964	6339	5670	5996	5326
72,40							6450	5758	6088	5400	5800	5142	5454	4796
69,40					6284	5574	5891	5210	5637	4960	5369	4722		
66,40			6068	5366	5725	5026	5456	4786						
63,40	5989	5293	5526	4835	5212	4524								
60,40	5454	4770	5115	4436										
57,40	5054	4381												

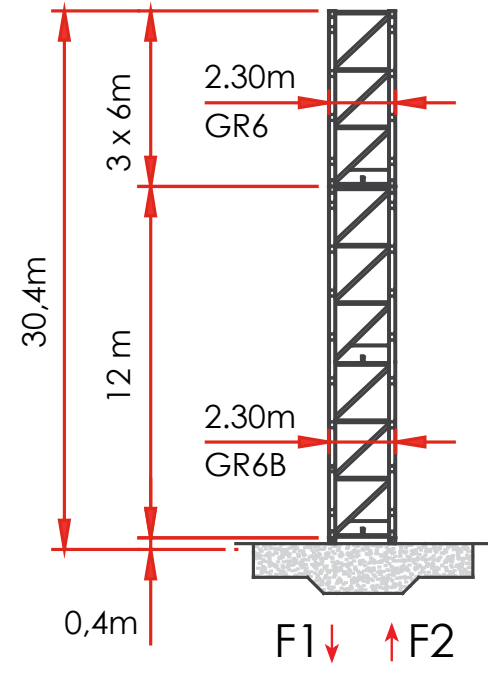



TOWER

HEM profile
Manufactured with high quality steel
Four bolts for each corner to connect the GR6 series mast section
Aluminum ladders for safe access
Access is fully compliant with EN14439
Hot-dip removable galvanized rest platform

Full details to be revealed during the LR330 showing at Intermat 2018 in Paris, France



HOISTING WINCHES

110 kW motor with double brake
Original LeBus Drum
Rope capacity 980m
Emergency secondary brake as an option
Inverter closed loop control

LOAD	TWO FALLS [M/MIN]	LOAD	ONE FALLS [M/MIN]
18000	0	9000	0
18000	18	9000	29
18000	31	9000	62
14000	38.5	7000	77
9000	58	4500	117
6000	84	3000	168
3600	107	1800	215
2850	117	1425	233
2600	123	1300	245
1600	128	800	257
0	128	0	257

HOISTING WINCHES

110 kW motor with double brake
 Original LeBus Drum
 Rope capacity 980m
 Emergency secondary brake as an option
 Inverter closed loop control

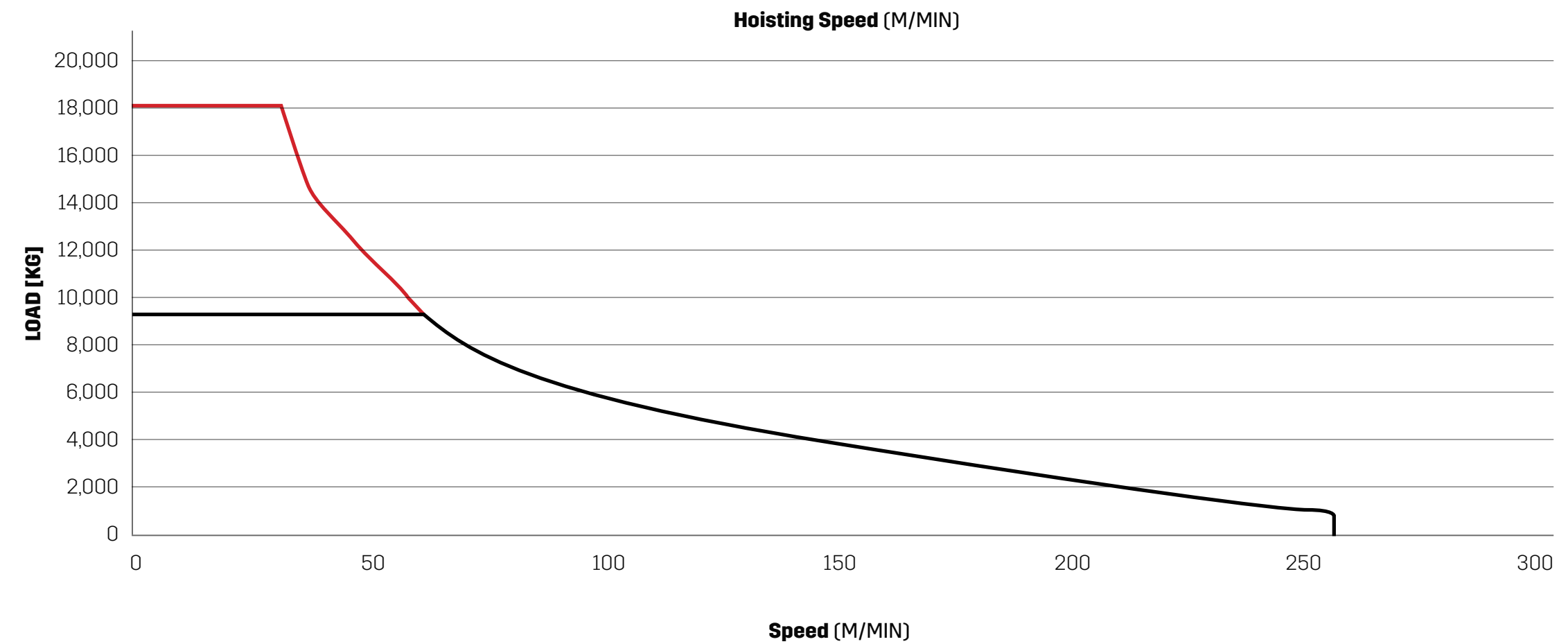

LOAD	TWO FALLS [M/MIN]	LOAD	ONE FALLS [M/MIN]
18000	0	9000	0
18000	11	9000	22
18000	22	9000	44
14000	28	7000	57
9000	44	4500	85
5300	67	2650	133
3600	80	1800	160
2850	44	1425	173
2600	93	1300	186
1600	111	800	222
0	111	0	222

HOISTING WINCHES

- 80 kW motor
- Original LeBus Drum
- Rope capacity 850m
- Emergency secondary brake as option
- Inverter closed loop control

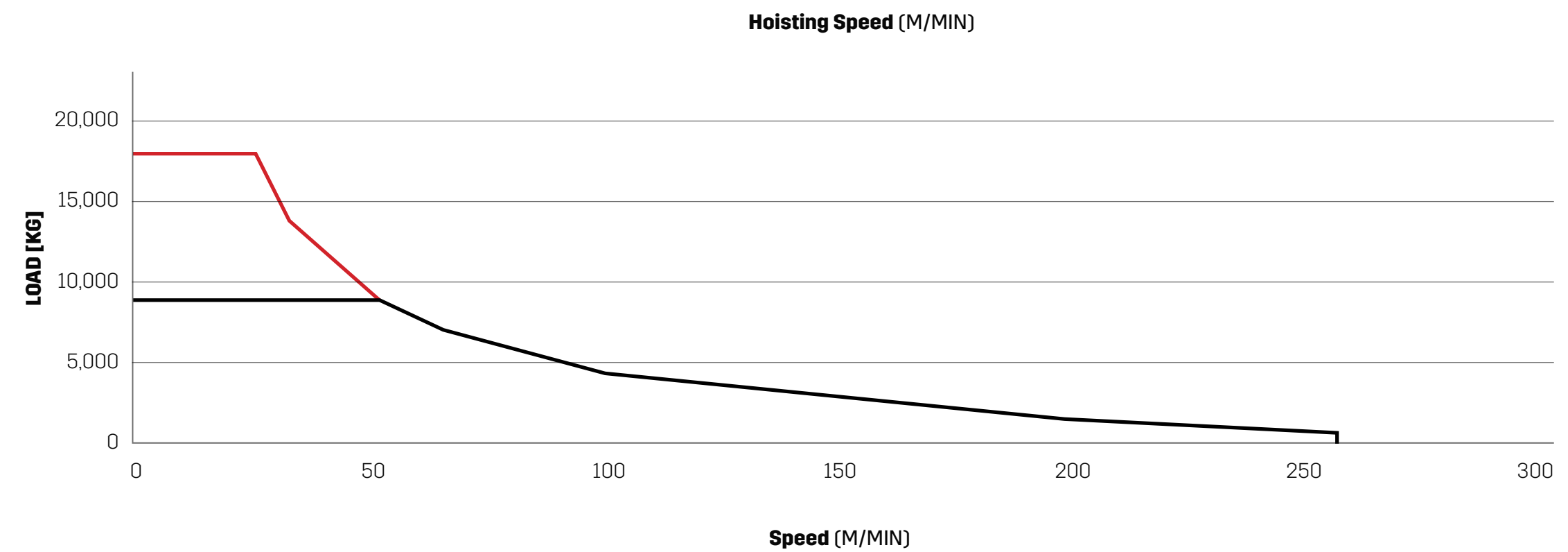

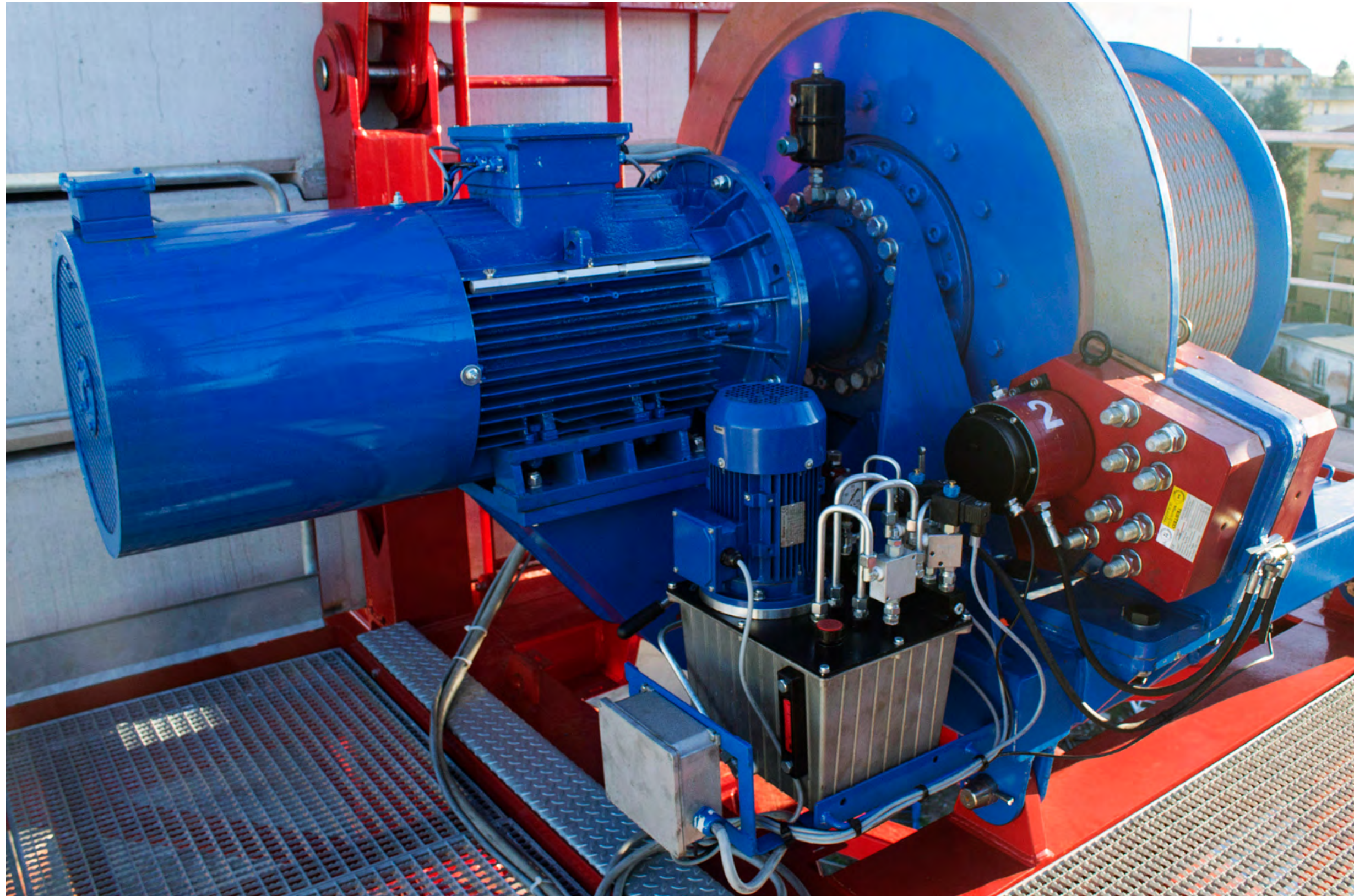

LUFFING WINCH

75 kW Motor
Original LeBus Drum
Emergency secondary brake
Inverter closed loop control
From 15° to 85° 1.8 minutes



SLEWING SYSTEM

- 2x15 kW motors
- Automatic Variable Brake
- Inverter closed loop control
- From 0 to 0.8 rpm
- Auxiliary Winch for rope installation

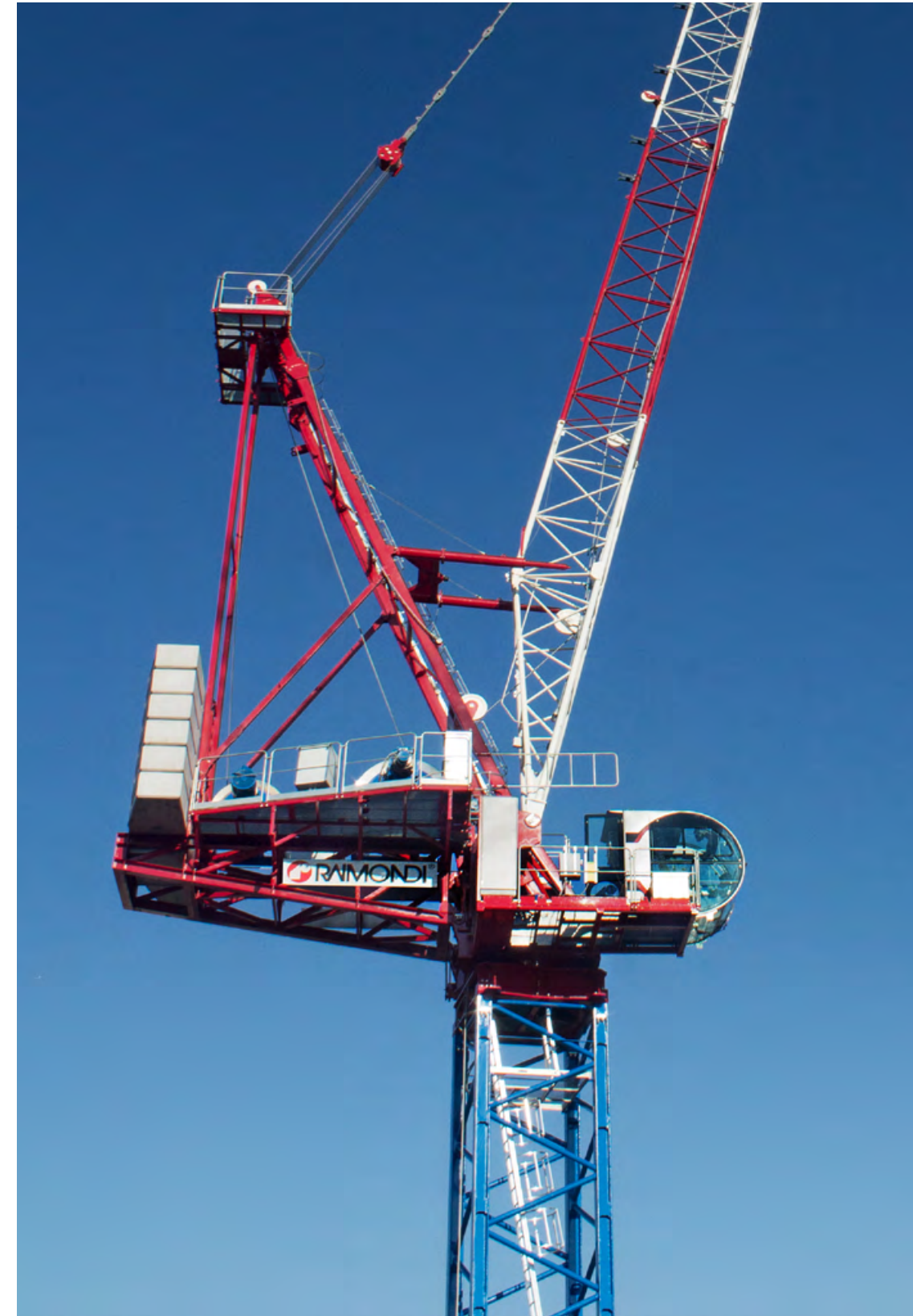

ACCESS

- Hot-dip galvanized platforms
- Aluminium ladders
- Easy and safe access to the jib
- Hot-dip galvanized walkways along the jib



INSTALLATION

- > Attention to the details related to the installation phases during the assembly of the crane
- > Pin connection system for the jib elements
- > Jib elements delivered ready for assembly, preempting the accessory installation on the jobsite
- > Quick assembly with two technicians to assemble the full jib and tie at ground level
- > Jib designed to be installed in full configuration (60m) with the hook block already connected in one lift when required and/or possible.
- > Support baskets to accommodate and temporarily fix the pins allowing easy pin insert without technician effort
- > Comfortable and secure access and platforms along the jib, the A-Frame and the counterjib, for an easy and safe installation and dismantle phase
- > Few lifting operations to install the upper parts quickly with auxiliary winch inverter controlled to install the ropes (luffing and hoisting)
- > Easy commissioning through the operator panel in the crane cabin
- > As per Raimondi standards, frequency converter control with remote control installed in each LR330 crane



SAFETY CONTROL SYSTEM

- > Full closed loop control of the movement by Invertes (new Schneider models)
- > Safety PLC to reach high level of Safety (PLc and PLd)
- > Redundant Electronic sensors
- > Only one Electric Cabinet for an easy maintenance
- > New Touch Screen 7" (16:9)
- > Teleservice available
- > Easy and fast commissioning only using the touch screen inside the cabin
- > Active safety controls

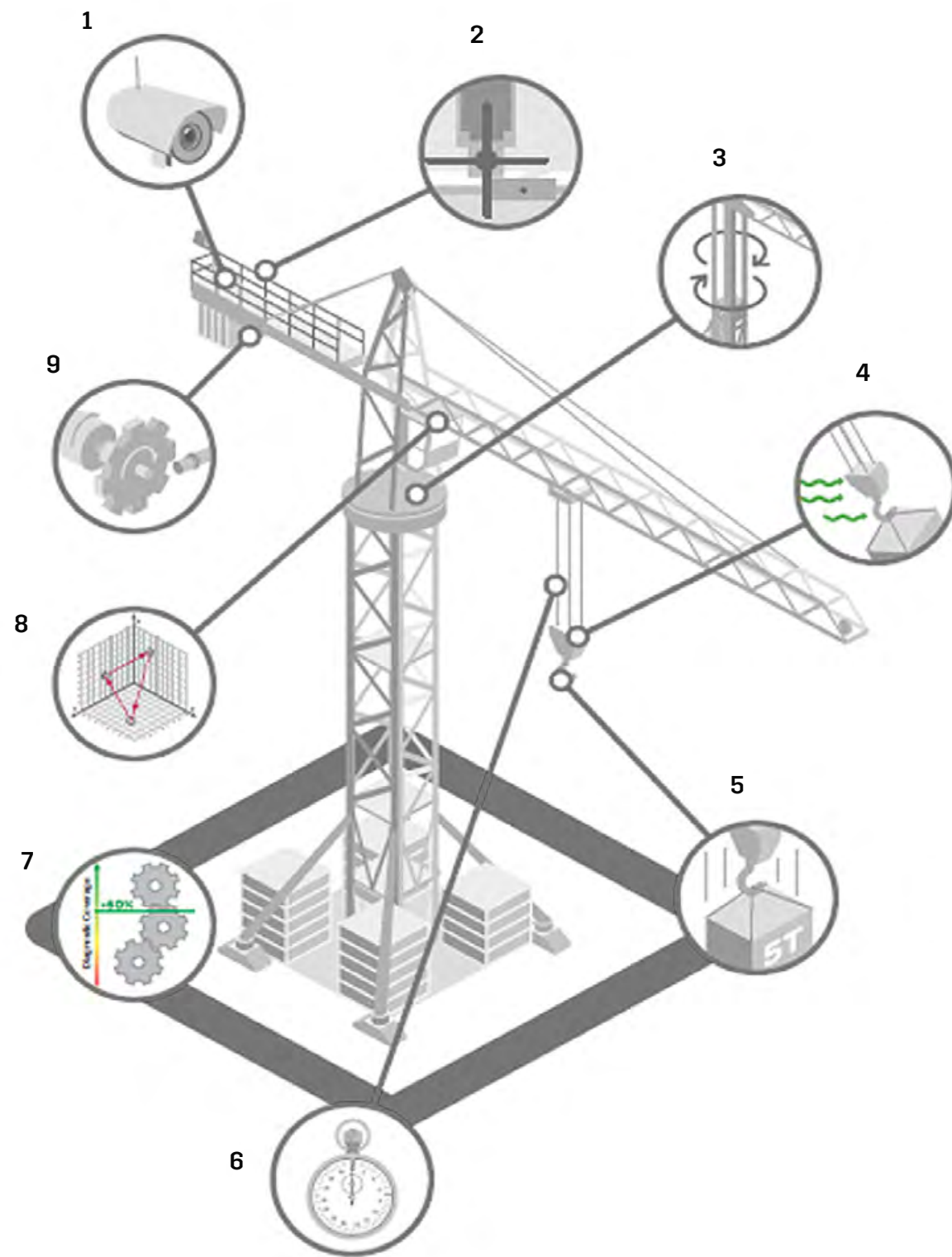

 Diagnostic Coverage	 Advanced Positioning	 Monitoring Data Storage	 Limit Switch Management
 Speed Optimization and Rope Slack	 Anti-sway open Loop	 Smooth Slewing	 Overload EN 15011
 Load Overspeed Control	 Hoisting Position Sync	 Wind Speed Control	 Anti-crab

SAFETY CONTROL SYSTEM

1. Monitoring data storage
2. Limit switch management
3. Smooth slewing
4. Wind speed control
5. Overload control EN15011
6. Speed optimisation rope slack
7. Diagnostic coverage
8. Advanced positioning
9. Load overspeed control



IN ACCORDANCE WITH EUROPEAN STANDARD EN 14439:2006+A2, THE RAIMONDI DELUXE R16 CABIN WAS DESIGNED WITH PARTICULAR ATTENTION TO SAFETY, ERGONOMICS AND QUALITY.

DELUXE R16 CABIN

Equipment supplied

- › Glass entry door for improved rear visibility
- › Panoramic glass with non-reflective system designed to increase thermal and acoustic insulation
- › Side sliding glass to enhance functionality and aesthetics
- › Ergonomic seat
- › HMI - Control system with Raimondi V4 Touch Screen (optional)
- › Anti-collision system (optional)
- › Joystick with safety release system (DMS)
- › Windscreen wipers
- › Internal LED light
- › Power outlet
- › Non-slip mat
- › Fall-protection bars and grid
- › Heater (optional)
- › Raimondi air conditioning system (optional)
- › New safety system to prevent accessories falling in the event of breaking of fixtures or during maintenance
- › Fire extinguisher



www.raimondi.co     

Raimondi Cranes is proudly headquartered in our ancestral home of Legnano
Corso Garibaldi, 253 - 20025 Legnano, Milan, Italy | +39 0331 548 061 | info@raimondicranes.com
Fourth Floor, Meydan Office Towers, Meydan Hotel, Nad Al Sheba, Dubai, UAE PO Box 644753 | +971 (0)4 381 3755